

Bar Coding 101... What You Need to Know



A ZEBRA BLACK & WHITE PAPER

For assistance with your barcode solutions, contact Dasco a Zebra Associate Partner

DASCO

1.800.927.7701

www.dascomedical.com

info@dascomedical.com





Copyrights

©2007 ZIH Corp. ZebraLink, ZebraDesigner, and all product names and numbers are Zebra trademarks, and Zebra and E3 are registered trademarks of ZIH Corp. All rights reserved. UPS is a registered trademark of United Parcel Service. FedEx is a registered trademark of Federal Express Corporation. TrueType is a registered trademark of Apple Computer Corporation. Bluetooth is a registered trademark of Bluetooth SIG, Inc. All other trademarks are the property of their respective owners.

Unauthorized reproduction of this document or the software in the label printer may result in imprisonment of up to one year and fines of up to \$10,000 (17 U.S.C.506). Copyright violators may be subject to civil liability.



Introduction

Bar coding, a form of keyless data entry facilitating automatic identification and data collection (commonly referred to as Auto ID), is not just for grocery stores anymore. The familiar stripes are popping up in new and unusual places such as doctors' offices, law firms, post offices, retail stores, security applications, and rental cars. Bar coding and related technologies have been used in manufacturing companies for shipping and receiving operations for more than 30 years. But even in these more traditional settings, bar code applications have spread throughout the enterprise to include warehousing, accounting and customer service functions, time and attendance, and package delivery, as well as the assembly line operation itself.

In all of these applications, the motivation to begin bar coding is the same: improve **data management** and **accessibility** and **reduce costs**. In the 1970s and 1980s, the increased use of computers in the commercial and industrial companies fueled the need for improved data capture. Companies hired armies of data entry professionals tasked with entering repetitive information into network terminals. In the 1990s, this need for immediate and accurate reporting was compounded with the introduction of just-in-time inventory tracking, build-to-order manufacturing and supply chain management practices. Today, many manual data entry tasks have been replaced by bar coding.

The widespread acceptance of bar coding within industry over the past three decades has led to the development of numerous industry standards by formidable industry groups, such as AIAG (Automotive), EIA (Electronics), HIBCC (Healthcare), and HAZMAT (Chemical) to name a few. Such standards ensure universal compliance and easy identification of product shipments among trading partners in the supply chain as well as ensure that product (such as hazardous chemicals) is handled properly to prevent injury or loss of life.

Benefits of Bar Coding

Improved Data Accuracy

Improved data accuracy is the single most common motivation for implementing a bar code system. Often the backbone of operations, data entry enables a company to produce accurate reports and predictions about future needs and actions. With data entry playing such a critical role in a company's operations, it is important to identify the extent to which data entry errors are tolerated.

Companies with integrated bar coding systems that enable users to scan bar codes rather than type numbers are commonly achieving 99% data accuracy. For companies in which data errors are a mere nuisance, the difference between 85% and 99% may not seem that extreme. But for organizations in which data entry errors are catastrophic, such as hospitals, crime labs, and manufacturing companies, the goal is 100% accuracy. Bar coding is the best tool that these organizations have to ensure data credibility and thereby greatly reduce the impact of human error.

Efficiency Benefits

Besides providing near-perfect accuracy, bar coding also enables users to work faster, without sacrificing accuracy. When factoring in the time it takes to correct simple data entry errors, it is easy to see the improved efficiency that comes with bar coding. In addition, by providing computer systems the capability to "see" exactly what is happening within an organization, bar codes enable instant conversion from physical actions into digital



transactions. This conversion of former manual tasks to electronic processes occurs in real-time, increasing efficiency and allowing management to make decisions based on current data and personnel to be employed in other, more productive areas.

While the time saved in data entry operations is easily recognized, the true efficiency improvements emerge when bar coding capabilities are extended to other areas of the organization, resulting in functional automation. This automation greatly simplifies information collection, processing, and tracking.

Consistency

Bar coding, particularly in fast-paced industrial environments, enables consistent and predictable operations for enhanced product quality by combining data management functions and preventing bottlenecks at data entry stations. Auto ID systems usually operate at a defined pace, either self-determined by the printer's maximum speed or triggered by the action of another device. For instance, in an assembly line, operations that were previously slowed by congestion at the point of data entry can now progress smoothly through a system of automated print-and-apply labeling machines and fixed scanners. In addition, employing standardized bar code symbologies and compliance labeling ensures that bar code information is captured and relayed in a manner that is universally understood and accepted.

Improved Inventory and Asset Management

Bar coding can help any company get a handle on resources. Companies are routinely bar coding assets such as manufacturing equipment, computer hardware, office furniture, and tools in order to record the number of each item, as well as the condition, color, features, and designated user. Libraries around the world are starting to place bar codes on books to track borrowing history. Likewise, automotive fleet owners, public transportation agencies, and rental car companies have begun utilizing bar codes to track detailed maintenance records for each vehicle. Manufacturing companies have similar applications in place to track both resource and finished product inventories.

Many companies complete the manufacturing process by affixing a label to the finished product, container or pallet. This label often contains very specific information about the product in both bar-coded data and human-readable text. The human-readable portion of the label is likely to describe the product characteristics, the packaged quantity, and the names of both the manufacturer and the customer, if known. The bar code contains internal information such as production line number, date of completion, materials used, serial numbers, and miscellaneous quality control information. By scanning the label in the shipping department, the company can identify the exact inventory, in real time, as well as the precise date and time that any product leaves the warehouse.

C o s t / B e n e f i t A n a l y s i s

Besides the cost of the equipment, including the printer, scanner, and media, the cost justification of an Auto ID system can be a tricky computation. It is widely thought that most Auto ID systems pay for themselves in less than two years, but this figure is dependent on a company's commitment to widespread implementation and acceptance of the bar coding technology. The "two year" argument alone is often not enough to gain approval of a proposed bar coding system and, similarly, is not even a sound consideration when planning an executive-mandated automation project.



Bar coding only generates a profit when supported by improved processes. When considering bar code implementation, every possible process improvement should be evaluated. There are some obvious improvements that can be achieved by implementing Auto ID systems, such as placing bar codes on retail goods to spare employees from manually entering each product's price or serial number. There are also several new capabilities and controls that appear from the improved data management achieved by implementing a bar coding system, such as Enterprise Resource Planning (ERP), wireless networking options, and RFID smart labels (human-readable label embedded with a computer chip that acts like a portable data file for the product at hand).

The initial cost savings companies discover after implementing an Auto ID system include: labor cost reduction, improved customer service and supplier response times, capital and inventory management, space management, and equipment costs.

In addition to the apparent savings, each of these areas also produces several hidden savings that must be considered during the cost analysis, though the answers may not surface until the implementation is complete. Once the data entry on the production line is automated, can production be sped up? If we create unique bar codes for each product, can the company fulfill customized solutions? Once inventory is monitored in real time, can we trim warehousing costs? These are just a few examples of the hidden gains resulting from bar coding. Several other opportunities will emerge as the use of Auto ID gains synthesis with operations.

Bar Code Printing Technologies

The variety of technologies available for bar code printing can be overwhelming. Further complicating the decision is whether it is better to invest in a bar coding system or to purchase pre-printed bar code labels.

On Demand vs. Pre-Printed Labels

Thousands of companies have benefited from ordering pre-printed bar code labels from service bureaus rather than investing in a bar coding system. Pre-printed labels are useful in operations that require only a low volume of identical (i.e., fixed, non-variable data) labels, often with extensive use of colors or graphics.

However, companies that start with pre-printed labels quickly discover the limitations of this solution option. Besides restricted flexibility, the use of pre-printed labels prevents companies from including variable customer data or combinations of text and bar code information. As a result, most companies find the financial commitment of printing on-demand bar codes worth the initial investment because of the added value from printing customized information on each label. For many applications requiring high-volume, mission-critical labels, the added cost of pre-printed labels quickly exceeds the cost of the entire system. To the surprise of many bar coding novices, most of the companies that order pre-printed labels also have bar coding systems. The pre-printed labels are ordered with the necessary color, graphics, or standardized text (such as return addresses on shipping labels) and are then fed through a bar code printer to receive customized (i.e., variable) information.

Whether a user elects to use pre-printed or plain labels, media selection is critical to the success of any bar code integration. The variety of ribbons, paper, and synthetic labels and tags is too great for discussion in this document, but the bar code application, the intended life span of the label, and the environment to which the label will be exposed all have a direct impact on media selection. It is advisable to pre-test a variety of media in an application before purchasing mass quantities.

Printing Technologies

Individuals new to bar coding often gravitate toward familiar technologies (such as laser printers, dot matrix printers, or ink jet printers) that are already connected to a network and, therefore, deemed suitable for bar code labeling. While these printers can be used for some very simple applications, they have serious limitations that make them inadequate for professional labeling. The common limitations among these traditional office technologies include print speed and flexibility, as well as the inability to print labels that are durable enough, or have the longevity or clarity required for all but the most basic bar coding applications.

Dot Matrix Printing

Dot matrix technology uses a hammer or pin to transfer pigment from a ribbon onto the substrate (see Figure 1). Due to the inaccuracy of dot placement and low resolution of the printing technology, these printers are nearly unusable for bar coding.

Advantages

- Dot matrix printers are readily accessible and inexpensive to purchase.
- They can print on virtually any type of form, check, or document and can print on wide-web, multi-part (carbon) forms.
- Dot matrix printers use multi-pass ribbons, which can result in reduced overall cost for ribbons and label materials.

Limitations

- Dot matrix printers print low- to medium-density bar codes that may not meet certain end-user guidelines. The dot size on the matrix printer limits the narrower element size and density of the bar code.
- Continuous ribbon re-use on dot matrix printers requires close monitoring of ribbon condition to ensure adequate bar code contrast. Ribbon ink that has become exhausted can also produce an image that is inadequate for scanning, resulting in a low read rate and a high error rate.
- Ink saturation can result in paper “bleed” which can cause image distortion.
- A dot matrix-printed label is limited in durability. Dot matrix printers typically cannot produce chemical- or water-resistant labels.
- Printing of single labels results in significant waste. The design of the dot matrix printer’s print carriage, sitting far below the media, also does not allow the label space to be maximized.
- Dot matrix printing offers no graphics printing capability.
- Bar code print speed is greatly reduced when best ink coverage for optimal print quality is specified.

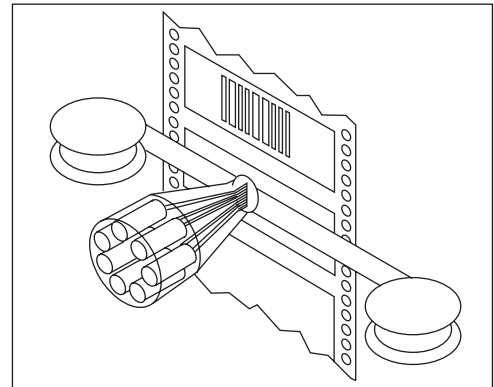
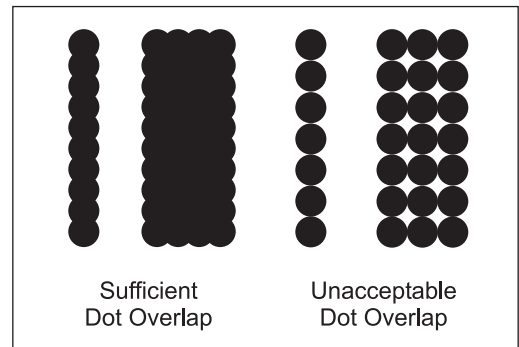

Figure 1. Dot Matrix Printing



Ink Jet Printing

Ink jet printing is used primarily for printing cartons or product packages with bar codes and human-readable data at very high speed. Ink jet printers spray ink onto the label surface in either a continuous stream, covering the entire print width with one spray, or one drop at a time (see Figure 3). However, ink jet printing is not acceptable for most bar coding applications.

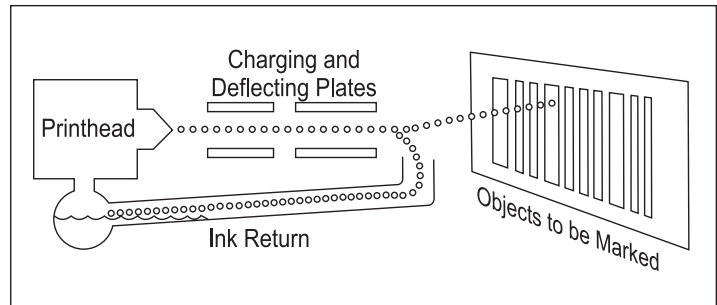

Figure 3. Ink Jet Printing

Advantages

- Direct ink jet printing requires only one step, while label printing requires two: printing the label and adhering the label to the product.
- High-speed ink jet printing is a favorite on high-speed production lines due to its ability to mark “on-the-fly.”

Limitations

- Ink jet printers are often too slow and are unable to reproduce bar codes with acceptable accuracy.
- System installation is costly because it is designed for high-volume bar code printing—not for individual or small batch printing.
- Ink jet printing requires diligent supervision and maintenance to ensure consistent print quality and prevent ink jet clogging.
- Dot placement accuracy and bar code density/resolution are limited due to ink splatter and because the print surfaces are in continual motion.
- Most inks used with this technology are water-based and, therefore, streak, run, or blur when they come in contact with water. Non-water-soluble inks are available, but these inks often produce a shine that reflects light back to the scanner, rendering the bar code unscannable.
- Bar codes printed on the dark background of corrugated box materials suffer from poor contrast and poor readability.
- Scanning devices must be carefully chosen to ensure reliable bar code reading.

Laser Printing

The laser printer works much like a photocopier; it projects controlled streams of ions onto the surface of a print drum, resulting in a charged image. The charged image then selectively attracts toner particles, transferring the image onto the paper substrate. After the image is transferred to the media, the heat and pressure of the fuser cause the image to adhere to the media (see Figure 4).

Advantages

- Laser printers are good at producing plain-paper documents that require bar codes.
- They can print high-quality text and graphics on paper documents and can double as a document printer when not being used to print bar codes.

Advantages (cont.)

- Bar code density and resolution are also quite high on laser printers, resulting in a scannable code at virtually any wavelength using an infrared scanner.

Limitations

- Laser printers are not well suited for industrial or individual-product labeling operations. They can be wasteful, as they cannot produce single or small labels. A minimum of half a page of media is typically required for the printer to maintain control of the sheet. Unless the label is at least that size or multiple labels are needed at once, the remainder is wasted.
- Laser printer label adhesives must be carefully selected to ensure stability under the heat and pressure of the fuser. Otherwise, the adhesive may extrude onto the printer mechanism where it captures stray toner, or may cause the labels to curl at the edges. Because of the pressures used in the laser printer image transfer process, many laminated label materials are not compatible with this technique. Those materials that are compatible may not always be available in the sheet form necessary for laser printing.
- Laser printing is susceptible to toner flaking and smudging, making the technology unsuitable for long-term bar coding.
- A laser-printed paper label has limited durability. For example, laser printers cannot produce chemical- or water-resistant labels and images.
- Toner, drum, and supply costs can skyrocket when printing bar codes instead of typical text on laser printers. While text generally requires only about 5% black ink coverage, bar code needs can exceed 30%. Toner costs alone could be six times higher when printing bar codes rather than text.

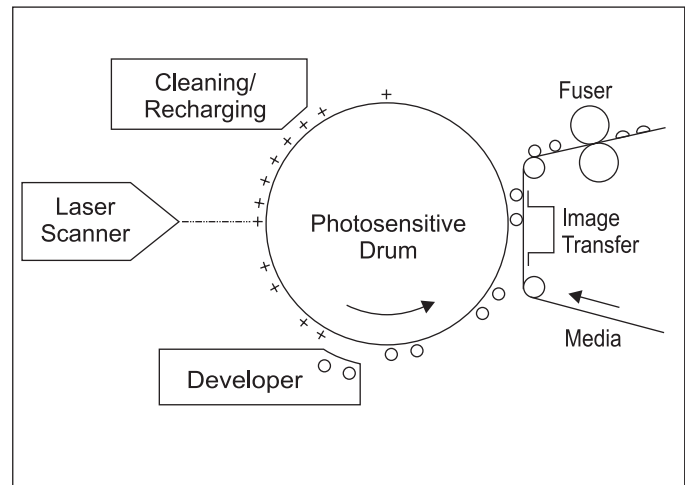

Figure 4. Laser Printing

Thermal Technology

The most widely used technologies for dedicated bar coding systems are direct thermal and thermal transfer printing. Both technologies use a heated printhead to create the image on the label, however, they are suited to different applications.

Direct thermal printing utilizes heat-sensitive media that blackens as it passes under the printhead (see Figure 5). Because they print without a ribbon, direct thermal printers are noted for their simplicity. Direct thermal printed labels typically have a considerable shelf life but are not well suited for environments that expose them to heat, long periods of direct sunlight, or abrasion.

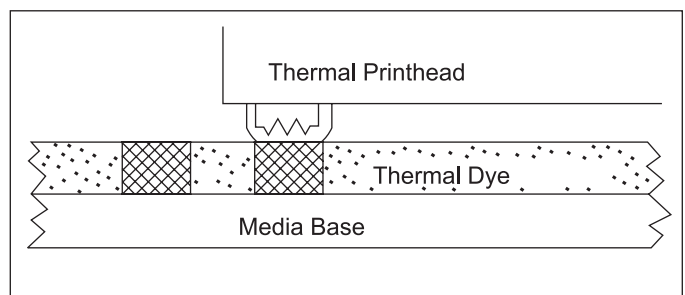

Figure 5. Direct Thermal Printing

Advantages

- Direct thermal printing produces sharp print quality with good scannability.
- Direct thermal is ideal for applications requiring only a short shelf life—meaning the label image does not need to last very long. Shipping labels and receipts are ideal applications, for instance, while product labels are not.
- Direct thermal printers are simple to operate compared to most other print technologies because there is no ink, toner, or ribbon to monitor or replenish.
- With no supplies to replace other than the material to be printed, long-term maintenance costs remain low.
- Direct thermal enables batch or single label printing with virtually no waste.
- With recyclable materials available, direct thermal printers offer environmental economy.
- Direct thermal printers are typically built more durably than dot matrix or laser printers, allowing reliable operation in industrial as well as office applications.

Limitations

- Direct thermal printing is extremely sensitive to environmental conditions such as heat and light (fluorescent and/or direct sunlight).
- Direct thermal paper remains chemically active after printing. Because of this, thermal labels, tags, or ticket stock are often top coated to resist UV light exposure, chemicals, and abrasion.

Thermal transfer printed labels are easily identified by the crisp, often glossy, printed surface. The clarity is achieved by using a thin ribbon roll that when heated by the printhead melts onto the label to form the image (see Figure 6). When matched with suitable media, thermal transfer technology is not only impervious to heat and moisture, but the image cannot be rubbed off, making the printed labels the most durable available. An additional benefit of this technology is the continuity of the printed image. Because the color and density of the printed image is determined by the ribbon and the resolution of the printer, thermal transfer printing produces consistent, reliable printing on every label.

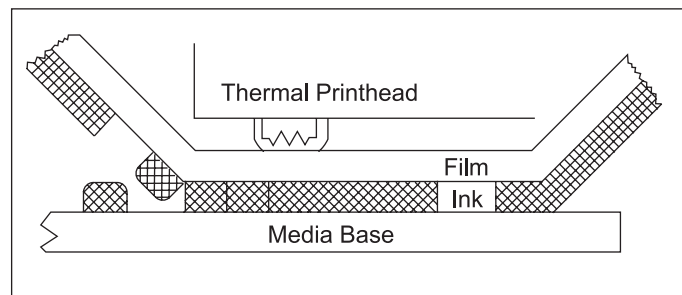

Figure 6. Thermal Transfer Printing

Advantages

- Thermal transfer delivers crisp, high-definition text, graphic, and bar code print quality for maximum readability and scannability.
- Thermal transfer printing produces long-life image stability.
- Thermal transfer enables batch or single label printing with virtually no waste.
- Long-term maintenance costs are low compared to dot matrix, ink jet, and laser printing.

Advantages (cont.)

- Thermal transfer technology can print on a nearly unlimited variety of media stock (except multi-form).
- Thermal transfer printers are typically built more durably than dot matrix or laser printers, allowing reliable operation in industrial as well as office applications.

Limitations

- Since thermal transfer printers require ribbon, supply costs are higher than direct thermal; however, thermal transfer printheads last longer than direct thermal printheads.
- Single-pass thermal transfer ribbon can be wasteful if little is printed on it.
- Thermal transfer ribbon is a poor candidate for recycling.
- To obtain optimum print quality in thermal transfer printing, the ribbon and media substrate MUST be compatible. Otherwise, the heat from the printhead could melt the ribbon onto the label causing internal printer problems.

Bar Code Print Technology Matrix

Technology	Print Quality	Scanner Readability	Initial Installation Cost	Long-Term Maintenance Cost	Materials Waste
Dot Matrix	Fair	Low	Low/Moderate	Moderate/High	High
Ink Jet	Moderate	Low/Moderate	High	Moderate/High	High
Laser	Moderate	Moderate	Moderate/High	Moderate/High	High
Direct Thermal	Moderate/Excellent	Moderate/Excellent	Moderate/High	Low	Low
Thermal Transfer	Excellent	Excellent	Moderate/High	Low	Low

When to Select Thermal Printing

Direct thermal or thermal transfer printers are best when you need any of the following:

Point-of-Application System

“Point-of-application” means the printer is located where the label is applied. By printing labels where needed and when needed (on demand), thermal printers can increase productivity. Point-of-application printing is related to distributed printing, whereby printers are placed at various points throughout a facility. Thermal printers are smaller, simpler, more durable, and less expensive than laser or dot matrix printers, making them ideal for distributed printing.

Variable Data

Thermal printers are ideal for applications that require individual or batch labels with variable data fields that change frequently. In such cases, thermal printers promote efficient and flexible label production with virtually no label waste, enabling users to print only what they need when they need it.



Varying Label Sizes

Thermal printers are ideal for labeling applications requiring varying label widths and/or lengths because they adapt easily to a variety of label sizes. (In fact, on thermal printers with wide print widths, labels of assorted sizes can be printed at once.) Laser and dot matrix printers cannot make such claims because the variety of label materials and sizes in sheet or pin-feed format is limited.

Graphics and Scalable Text Font Sizes

Thermal printers can cleanly print any graphic image, including logos. Additionally, text fonts are “scalable,” meaning that they can be adjusted to any point size requirement. (Bitmap fonts, by comparison, are only adjustable to a limited number of point sizes—e.g., 8, 10, 12, 14, 16, or 18 points). Dot matrix printer software does not allow such flexibility.

High-Definition Bar Codes

Thermal printing is ideal where high-definition bar codes are required. Bar codes printed on direct thermal printers—including complex, 2-D bar codes—offer the highest first-time scan rates of any printing technology, reducing errors and increasing productivity.

Compact Printers

Thermal printers are clean and quiet. They are also more compact than dot matrix, ink jet, or laser printers. Thermal printers come in three basic varieties: tabletop, desktop, and mobile. Tabletop thermal printers are bigger than desktop thermal printers, primarily because of their ability to hold a full 8” roll of media compared to the 3”-5” roll capacity of a standard desktop printer. Mobile printers are the smallest because they are designed for portability, often hanging from a shoulder or belt strap.

Even tabletop printers that are comparable in size to some laser printers usually are designed to have a smaller “footprint” (the amount of flat surface area that is consumed). Desktop printers have a footprint about the size of an office phone or mouse pad. Only thermal printing technology offers the compact portability of mobile printers.

Low Operating Costs

Thermal printers tend to have a higher initial cost but a lower maintenance cost compared to other print technologies, resulting in a lower cost of ownership. Lower long-term maintenance costs can quickly offset the higher initial investment.



Selecting the Right Printer

Selecting the right printer is not as intimidating as it first appears. By describing the bar coding functions in specific terms and answering a few simple questions, users can narrow their printer choices considerably. The primary questions to ask are:

- What are the intended uses of the bar code labels?
- Where will the printers be located?
- In what kind of environment will the printers operate (temperature fluctuation, vibration, high humidity, exposure to chemicals, etc.)?
- What are the anticipated duty cycles for the printers?
- Are there any minimum speed requirements?
- What are the dimensions of the labels to be used?
- How frequently do label specifications change?
- What kind of environments will the labels be exposed to (temperature fluctuation, abrasion, high humidity, exposure to chemicals, etc.)?
- Will the printers be connected to a network or to stand-alone terminals?
- What is the budget for the project?

Other performance variables include the following:

Printer Durability

What sort of environmental conditions will the printer encounter? Some Zebra® printers, for example, are specifically designed for harsh industrial environments and have sealed cabinetry to prevent dust from interfering with operations. Rugged desktop printers may be ideal for light industry, commercial applications, and office use.

Print Volume

What is your daily label output? Zebra's high-performance Xi™ series printers are designed to operate continuously, during peak print cycles or non-stop for 24-hour cycles. Other models are better suited for lower volume, intermittent printing. Print speed is also a factor in meeting print volume requirements.

Print Speed

Print speed is an important consideration if you require a high volume of labels to be printed daily or during peak cycles. Print speed is an element of “throughput,” which is the time lapsed between receipt of the print command and completion of the printing process. Throughput depends not only on printing time, but also on label formatting time (i.e., the time required to convert the program and data to an image on the label). Depending on the complexity of the label format and the printer's ability to process this information in an efficient manner, label-formatting time can sometimes cause significant print delays, affecting a printer's overall print speed capability. Such delays can be costly in productivity if they occur in a production environment where time and on-demand print capability are of the essence.

Label Image Durability

Thermal transfer is the only alternative if crisp, long-lasting images are required to last for a number of years. Direct thermal printers, in comparison, are ideal for short-term applications where the label is only required to last for a limited amount of time—from one week to one year. Direct thermal is not as durable as thermal transfer, especially when exposed to direct sunlight or chemicals. Direct thermal paper varieties are also somewhat more limited than those available for thermal transfer printers.

Print Resolution

Depending on your application, higher resolution (measured in dots per inch or dpi) may be required to facilitate the printing of text and bar codes on very small labels, such as those commonly used in the electronics or pharmaceutical industries for component or specimen labeling. Higher print resolutions provide crisp, detailed printing of much information in small spaces, without impairing scanner readability. While many Zebra printers have 203 dpi resolution—adequate for most normal applications—other models offer 300 dpi and even 600 dpi for high resolution in applications where limited label real-estate exists or where high-resolution text and graphics are needed.

Print Width

Another factor in choosing a printer is determining the widest label you need to print. Zebra thermal printers, for example, offer an assortment of maximum print widths ranging from 2" (on mobile and some desktop printers) to 8.5" (for printing 8.5" x 11" packing slips and invoices faster and less expensively than laser printing). If your application demands large labels (e.g., shipping labels, multi-part invoices, or labels on large products and packages, chemical drums, or pallet wrap) you need to choose a wide-label printer with a print width of 6" or more.

Even if the application does not require large labels, sometimes a wide-label printer can still be advantageous. For example, while a 4" printer is able to print the common 6" x 4" compliance label format, it must rotate the information and print it lengthwise (4"W x 6"L). A 6" printer can print the same label laterally (the wide way) as 6"W x 4"L.

In the 4"W x 6"L format, the bar code is shown in a rotated, “ladder” style format (see Figure 7). The 6"W x 4"L bar code format is shown in a normal, “picket fence” style. It is more difficult for most printers to print rotated bar codes; rotated labels have to print more slowly to achieve the same bar code print quality. Zebra’s patented E3® printhead technology ensures that the correct amount of heat is delivered to each part of a printhead at all print speeds, optimizing the quality of the bar codes that are produced in either orientation. A 6" printer completes a 6"W x 4"L label three times faster than a 4" printer, and produces 50 percent more labels from a single media roll—saving media costs and stretching the time between media changes.

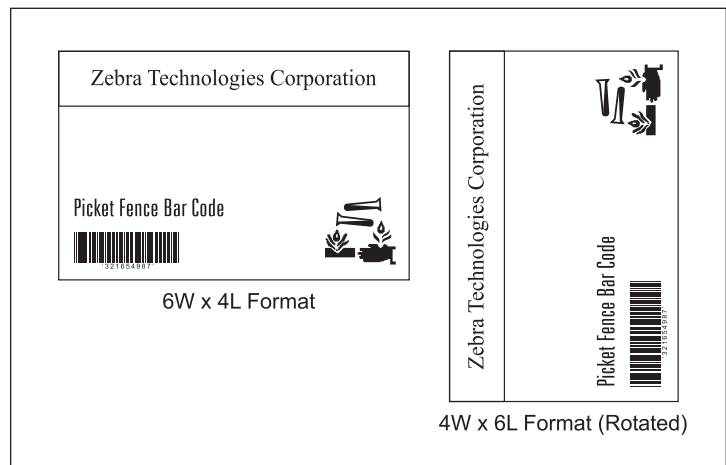



Figure 7. Label Styles



Wide-label printers can also multi-task, with “multiple up” printing. Using a single printer configured to print multiple formats, for example, an assembly station can print on demand all the component labels it needs for each assembly. Similarly, wide-label printers allow “multiple cut” printing that is valuable for batch printing; a 6" printer can print six 1" die-cut labels across simultaneously.

Printer Feature Options

Additional factors to consider when purchasing a particular thermal printer are its available options. These options may include:

- Different print modes: label cutter, peel, liner take-up, tear, rewind, etc.
- Real-time clock for printing the time and expiration date.
- Advance counter for alerting users when it is time to change media, perform preventive maintenance, etc.
- Communication options: parallel, serial, USB, wired or wireless Ethernet, twinax or coax cables, etc.
- Memory options: PCMCIA/Flash memory, upgradeable DRAM.
- Font options: Scalable vs. bitmap, non-Roman Asian font sets for international characters such as Chinese and Japanese, TrueType® fonts, etc.

Any of these options can help the printer meet application needs more closely and enhance the operator's productivity. The peel mode option, for example, can facilitate quicker label application. In peel mode, the printer separates the label from its liner backing, so rather than removing it manually, the user can simply take the label and affix it. Such timesaving options greatly facilitate label output and in some cases even improve worker morale.

When a proper balance is reached between printer performance and application, the printer becomes a more natural extension of the operator. The resulting higher efficiency can add to the organization's overall productivity and bottom line.

Choosing the Right Supplies

Selection of label material depends first on whether direct thermal or thermal transfer print technology is being used. For optimum printer performance and to extend the life of the printhead, it is important to choose the right media (or the right media and ribbon combination in the case of thermal transfer printing). Choosing the wrong media can result in poor print quality, printer malfunction, and/or frequent printhead replacement.

Thermal printers are designed to operate with a variety of media types, including: pressure-sensitive, die-cut, butt cut, perforated, notched, hole-punched, continuous, tag, or ticket stock labels. Figure 8 illustrates the most popular label varieties used.

Zebra's Supplies department carries over 1,000 combinations of high-quality, reliable labels, tags, and ribbons— over 300 of which have been UL and CSA approved. Regardless of your application, Zebra's supplies specialists can help you combine the right media supplies to meet your needs and optimize your bar code printer's performance.

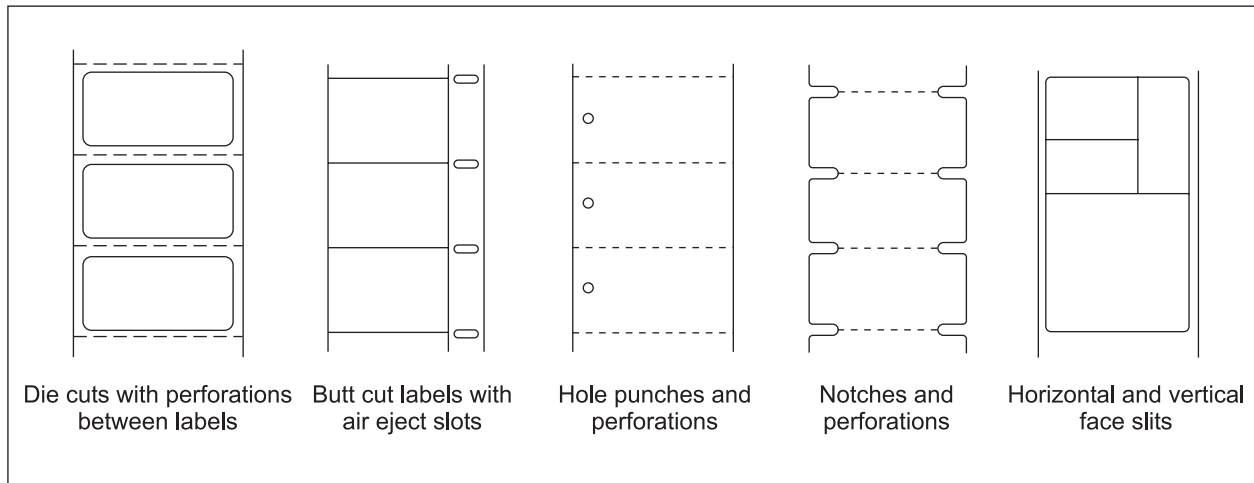

Figure 8. Popular Label Varieties

Integrated Bar Code Systems

Though the advance of bar coding has created new data management opportunities, much of the potential of bar codes remains untapped. Most bar code printers are connected to stand-alone personal computers (PCs) that control the bar code label design and function via a network print server. While these stand-alone systems, dubbed “island systems,” can still take advantage of bar code scanning to provide data automation, human users must direct the printer to print and manually enter nearly every piece of information.

The explosion of enterprise resource planning (ERP) software has given bar coding an enhanced role in corporate information systems. In island systems, the bar code printer has no direct interaction with the corporate enterprise. When connected to an ERP system, the printer can take direction from other processes and print and encode data automatically when the server directs it to do so.

ERP systems, when used alone or partnered with warehouse management software or supply chain management applications, are capable of producing detailed reports based on the information they gather from the system operations. This reporting capability can be used with bar code integration software to print labels containing this same information.

Zebra Applications/Solutions

Zebra offers the world's broadest line of thermal printing solutions—including the widest variety of high-performance, commercial/industrial, desktop, and portable printer options—to satisfy a full range of industrial, commercial, and mobile printing applications. Zebra printing solutions include label, receipt, and instant-issuance card printers, as well as printer supplies and label design software. Many new-generation Zebra printers are available with ZebraLink™ Solutions, Zebra's suite of networking, software, firmware, and printer management products designed for ease of printer integration and use, from small-business to enterprise supply chain applications.



For assistance with your barcode solutions, contact Dasco a Zebra Associate Partner



1.800.927.7701

www.dascomedical.com

info@dascomedical.com



GLOBAL/AMERICAS

HEADQUARTERS

Zebra Technologies Corporation
333 Corporate Woods Parkway
Vernon Hills, IL 60061-3109 U.S.A.

T: +1 847 793 2600 or
+1 800 423 0442
F: +1 847 913 8766

EMEA HEADQUARTERS

Zebra Technologies Europe, Limited
Zebra House, Unit 14,
The Valley Centre
Gordon Road, High Wycombe
Buckinghamshire HP13 6EQ, UK

T: +44 (0) 494 472872
F: +44 (0) 494 450103

ASIA-PACIFIC HEADQUARTERS

Zebra Technologies Asia Pacific, LLC
16 New Industrial Road
#05-03 Hudson TechnoCentre
Singapore 536204

T: +65 6858 0722
F: +65 6885 0838

OTHER LOCATIONS

USA

California, Rhode Island, Texas,
Wisconsin

EUROPE

France, Germany, Italy, Netherlands,
Poland, Spain, Sweden

ASIA-PACIFIC

Australia, China, Japan, South Korea

LATIN AMERICA

Florida (USA), Mexico

AFRICA/MIDDLE EAST

South Africa, United Arab Emirates